



DAS HERZ DER FRISCHE

WATER COOLED CONDENSERS

DP-270-1 EN



CRF SERIES



HEAT
EXCHANGERS



HFO
READY

Water cooled Shell and tube condensers: CRF SERIES

Applications

The new CRF condenser has been developed for HFC cooling applications at medium pressure (PS 30 bar) and high pressure (PS 48 bar) within refrigeration, process cooling and air conditioning.

The secondary fluid is usually normal water that can be in a closed loop with a cooling tower (tower application) or in an open loop with a well (city application). Some applications can use also glycol.

These applications usually require a condensation temperature in a range of +30°C/+50°C depending on the system working condition and its efficiency rating.

Technology

The CRF design has been optimized for R407C/F and R134a refrigerants but it can be also utilized with HFO1234ze, R410A, R404A and R507.

Thank's to its new high performance tubes, new headers, new shell and the new baffles, the BITZER CRF models provide maximum efficiency with a low cost/kW.

This is an important step ahead compared with the previous CDEW and CDEW-E models; the new CRF is ready to fight with competition.

Benefits

// High efficient condenser tube which allows an overall performance increase vs. CDEW models keeping the water pressure drop at the same level.

// Refrigerant connections optimized for R134a to reduce pressure drop values.

// Three tube lengths to match operating conditions with different temperature approaches.

// Compact design with about 15%-20% shorter length and weight comparing with existing solution.

// Water flow optimized to reduce the fouling and erosion risks.

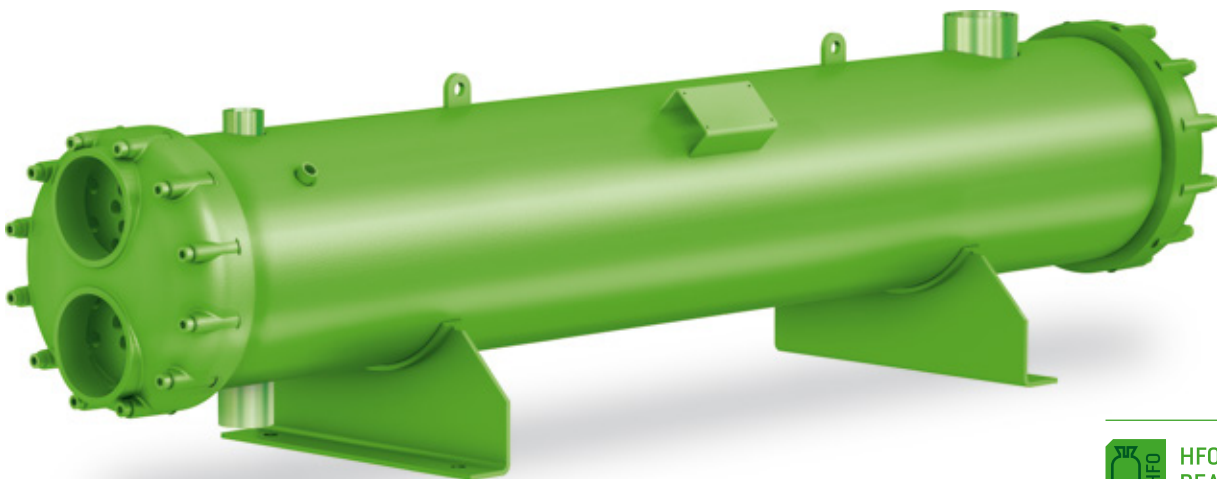

Design data
PED (CE) approval

Version	Tubes side				Shell side			
	DP (bar)	DT (°C)	Tmin (°C)	PT (bar)	DP (bar)	DT (°C)	Tmin (°C)	PT (bar)
STD	10	90	-10	14,3	30	120	-10	42,9
HP	16	90	-10	22,9	48	120	-10	68,6

DP Design Pressure // DT Design Temperature // Tmin Minimum temperature // PT Test Pressure

Denomination

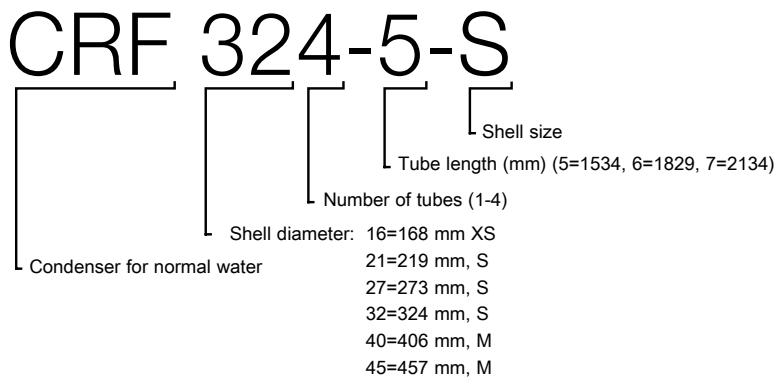

The XS-S-M in item's description is set according to shell diameter and the chart below.

Dshell Min - Max range				
	mm		Inches	
XS	51	168	2	6,63
S	194	324	7,63	12,75
M	356	457	14	18
L	508	610	20	24
XL	660	1007	26	42

Refrigerant connections

Refrigerant inlet and outlet are equipped with welding or Rotalock brazing connections.

Welding connections

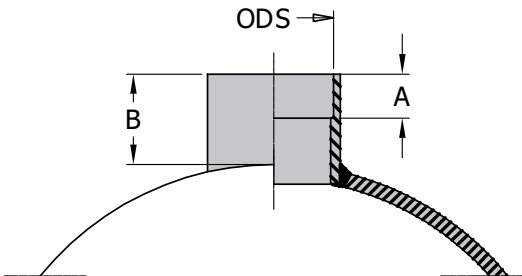

Welding		WA42	WA54	WA67	WA80	WA89	WA108
A	mm	20	20	25	25	25	25
B	mm	50	50	50	50	50	50
ODS	mm	42	54	67	80	89	108
OD	mm	48,3	60,3	76,1	88,9	101,6	114,3

Rotalock connections

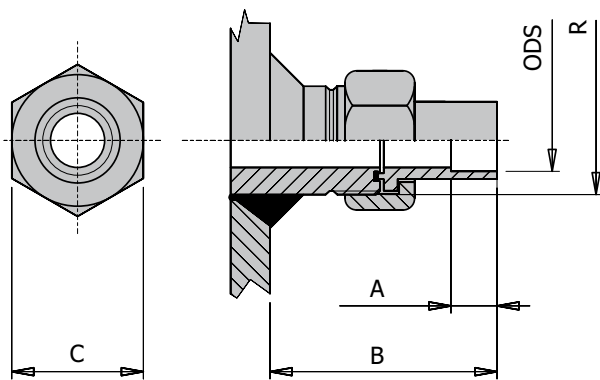

Rotalock		Type B	Type C	
A	mm	20	20	20
B	mm	80	80	80
C	mm	36	50	50
RT	-	1¼" 12 NF	1¼" 12 UNF	1¼" 12 UNF
Name	mm	RB22	RC28	RC35
ODS	mm	22	28	35
ID	mm	22,5	28,2	35,3

Brine connections

Water inlet and outlet connections on the condenser CRF are female threaded connections. Flange connections are available as option on request.

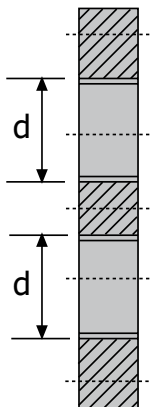

Water		d (in)
T1		1
T11		1½
T2		2
T21		2½
T3		3
T4		4
T5		5
T6		6



Options

Welded supports and sight glass are available as options. Please refer to 'General dimensions' table for standard interaxis of welded supports. The standard position of sight glass will be according to the drawing below.

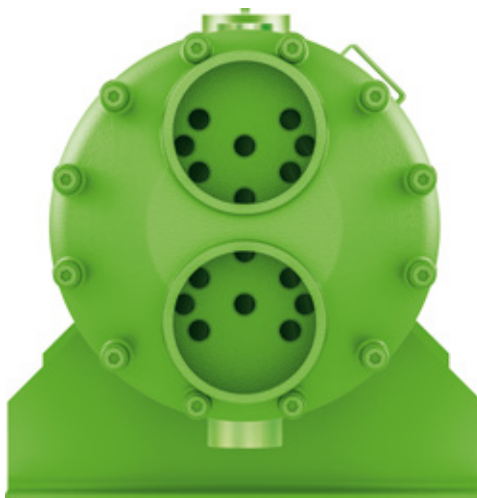
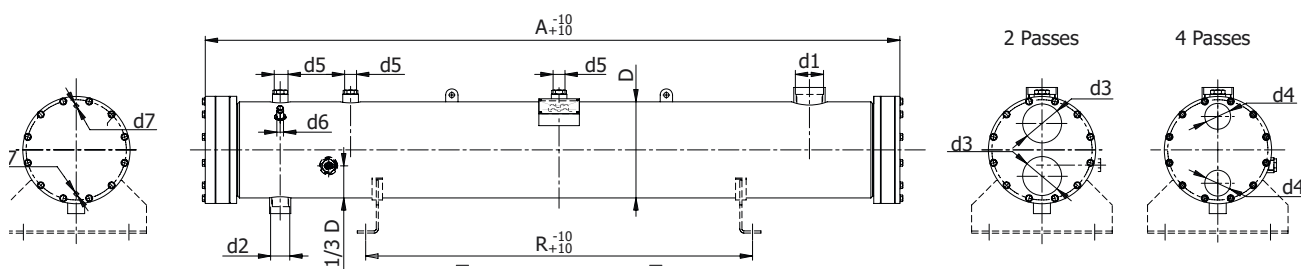

Capacity table

CRF serie has been optimized on three different shell sizes, according to the approach requested.

CRF (Tower version - 2P)																						
Ti = 30°C To = 35°C, SC = 3 [K], FF = 4.3E-05 [m²K/W]																						
CRF Model 5 ft	162-5 XS	163-5 XS	164-5 XS	211-5 S	212-5 S	213-5 S	214-5 S	271-5 S	272-5 S	273-5 S	274-5 S	322-5 S	323-5 S	324-5 S	401-5 M	402-5 M	403-5 M	404-5 M	452-5 M	453-5 M	454-5 M	
R407C Tc = 44,5°C (dew) Tg = 85°C	Qn (kW)	109	123	142	166	197	225	249	287	320	353	410	481	530	598	681	746	829	930	1003	1081	1151
R134a Tc = 40,0 Tg = 55°C	Qn (kW)	111	125	145	169	201	230	255	293	327	361	420	493	544	614	698	765	851	956	1030	1111	1184
CRF Model 6 ft	162-6 XS	163-6 XS	164-6 XS	211-6 S	212-6 S	213-6 S	214-6 S	271-6 S	272-6 S	273-6 S	274-6 S	322-6 S	323-6 S	324-6 S	401-6 M	402-6 M	403-6 M	404-6 M	452-6 M	453-6 M	454-6 M	
R407C Tc = 43,0°C (dew) Tg = 85°C	Qn (kW)	111	125	145	168	200	229	253	292	325	359	417	489	540	608	692	758	843	946	1020	1100	1172
R134a Tc = 38,5 Tg = 55°C	Qn (kW)	106	119	139	161	192	220	244	280	312	345	401	471	520	586	667	731	814	914	985	1062	1132
CRF Model 7 ft	162-7 XS	163-7 XS	164-7 XS	211-7 S	212-7 S	213-7 S	214-7 S	271-7 S	272-7 S	273-7 S	274-7 S	322-7 S	323-7 S	324-7 S	401-7 M	402-7 M	403-7 M	404-7 M	452-7 M	453-7 M	454-7 M	
R407C Tc = 42,0°C (dew) Tg = 85°C	Qn (kW)	113	126	147	170	203	233	257	296	330	365	424	497	548	618	704	770	858	962	1037	1117	1190
R134a Tc = 37,5 Tg = 55°C	Qn (kW)	101	114	132	153	183	210	232	266	298	329	382	448	495	558	636	697	775	870	938	1011	1079
Wm	(m³/h)	22,4	26,5	30,6	34,7	42,9	48,9	54,0	61,3	69,3	76,5	88,7	103,9	116,1	132,7	150,8	165,3	183,6	207,6	224,4	241,8	262,6

Ti Inlet water temperature
 To Outlet water temperature
 SC Subcooling
 FF Fouling factor
 Tc Condensing temperature
 Tg Inlet gas temperature
 Qn Condensing capacity
 Wm Water maximum flow

General dimensions

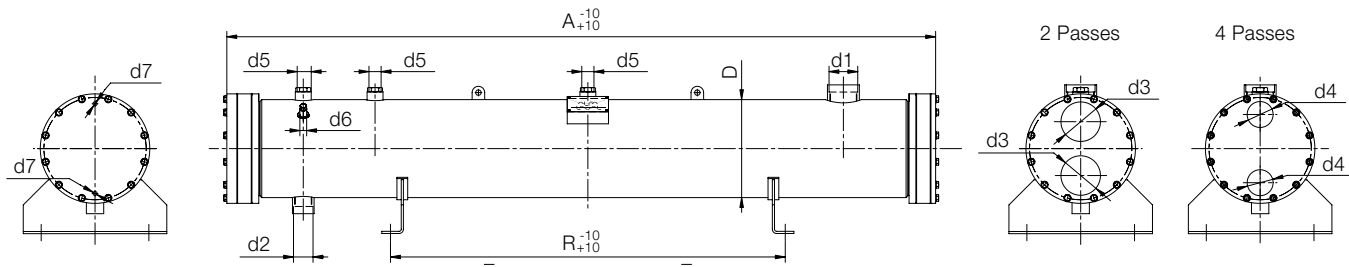

CRF Model 5 ft			162-5 XS	163-5 XS	164-5 XS	211-5 S	212-5 S	213-5 S	214-5 S	271-5 S	272-5 S	273-5 S	274-5 S	322-5 S	323-5 S	324-5 S	401-5 M	402-5 M	403-5 M	404-5 M	452-5 M	453-5 M	454-5 M
Dimensions	A	mm	1605			1620			1650			1670			1690			1715					
	D	mm	168,3			219,1			273,0			323,4			406,4			457,0					
	R	mm	900			900			900			900			900			900					
Connections	d1	mm	WA42			WA67			WA80			WA89			WA108			WA108					
	d2	mm	RCL35			WA42			WA54			WA67			WA80			WA80					
	d3	in-G	T2			T21			T4			T4			T6			T6					
	d4	in-G	T11			T2			T21			T3			T4			T5					
	d5	N°xin-NPT	1 x 1/2			1 x 3/4			1 x 1			2 x 1			3 x 1			3 x 1					
	d6	in-NPT	1/4			1/4			1/4			1/4			1/4			1/4					
	d7	in-G	1/4			1/4			1/4			1/4			1/4			1/2					
Volumes and weights	Vr	dm ³	21,4	19,9	18,3	38,6	35,5	33,1	31,2	56,4	53,2	50,5	45,8	73,6	68,9	62,6	121,8	116,3	109,3	100	141,1	134,1	126,7
	VH20	dm ³	7,6	8,7	9,8	12,7	15,0	16,6	18,0	22,8	25,0	26,9	30,3	36,9	40,3	44,7	55,0	58,9	63,9	70,6	78,7	83,7	89,0
	P	kg	61	65	68	98	105	110	114	172	179	185	194	237	247	260	387	398	413	432	511	526	541

CRF Model 6 ft			162-6 XS	163-6 XS	164-6 XS	211-6 S	212-6 S	213-6 S	214-6 S	271-6 S	272-6 S	273-6 S	274-6 S	322-6 S	323-6 S	324-6 S	401-6 M	402-6 M	403-6 M	404-6 M	452-6 M	453-6 M	454-6 M
Dimensions	A	mm	1910			1925			1955			1975			2000			2020					
	D	mm	168,3			219,1			273,0			323,4			406,4			457,0					
	R	mm	1100			1100			1100			1100			1100			1100					
Connections	d1	mm	WA42			WA67			WA80			WA89			WA108			WA108					
	d2	mm	RCL35			WA42			WA54			WA67			WA80			WA80					
	d3	in-G	T2			T21			T4			T4			T6			T6					
	d4	in-G	T11			T2			T21			T3			T4			T5					
	d5	N°xin-NPT	1 x 1/2			1 x 3/4			1 x 1			2 x 1			3 x 1			3 x 1					
	d6	in-NPT	1/4			1/4			1/4			1/4			1/4			1/4					
	d7	in-G	1/4			1/4			1/4			1/4			1/4			1/2					
Volumes and weights	Vr	dm ³	25,8	23,9	22,0	46,5	42,8	39,9	37,6	67,9	64,2	60,9	55,2	88,6	83,0	75,4	147,0	140,4	131,9	120,7	170,3	161,8	152,9
	VH20	dm ³	8,8	10,2	11,5	14,6	17,3	19,3	21,0	26,1	28,8	31,1	35,1	42,6	46,6	52,0	63,2	67,9	73,9	81,9	90,9	97,0	103,3
	P	kg	70	74	78	111	119	125	130	194	202	209	221	269	281	296	431	445	462	486	573	591	609

CRF Model 7 ft			162-7 XS	163-7 XS	164-7 XS	211-7 S	212-7 S	213-7 S	214-7 S	271-7 S	272-7 S	273-7 S	274-7 S	322-7 S	323-7 S	324-7 S	401-7 M	402-7 M	403-7 M	404-7 M	452-7 M	453-7 M	454-7 M
Dimensions	A	mm	2215			2230			2260			2280			2300			2325					
	D	mm	168,3			219,1			273,0			323,4			406,4			457,0					
	R	mm	1500			1500			1500			1500			1500			1500					
Connections	d1	mm	WA42			WA67			WA80			WA89			WA108			WA108					
	d2	mm	RCL35			WA42			WA54			WA67			WA80			WA80					
	d3	in-G	T2			T21			T4			T4			T6			T6					
	d4	in-G	T11			T2			T21			T3			T4			T5					
	d5	N°xin-NPT	1 x 1/2			1 x 3/4			1 x 1			2 x 1			3 x 1			3 x 1					
	d6	in-NPT	1/4			1/4			1/4			1/4			1/4			1/4					
	d7	in-G	1/4			1/4			1/4			1/4			1/4			1/2					
Volumes and weights	Vr	dm ³	30,2	28,0	25,7	54,5	50,0	46,7	43,9	79,5	75,1	71,2	64,6	103,7	97,1	88,2	172,1	164,4	154,5	141,3	199,5	189,6	179,1
	VH20	dm ³	10,1	11,6	13,2	16,5	19,6	22,0	23,9	29,4	32,6	35,3	40,0	48,3	53,0	59,2	71,5	76,9	83,9	93,3	103,2	110,2	117,6
	P	kg	79	84	88	124	133	139	145	216	225	233	247	301	315	333	476	492	512	540	635	655	677



BITZER Kühlmaschinenbau GmbH
Eschenbrunnlestraße 15 // 71065 Sindelfingen // Germany
Tel +49 [0]70 31 932-0 // Fax +49 [0]70 31 932-147
bitzer@bitzer.de // www.bitzer.de

The products can deviate in colour from the shown product pictures. // Subject to change // 80192401 // 09.2018